

# JRX115 15 Inch Two-Way Speaker

## JRX100

### Key Features:

- ▶ JBL 15" low frequency driver with a 64 mm (2½ in) diameter edge-wound ribbon voice coil which provides more cross-sectional wire area in the voice coil gap than round wire designs, for greater efficiency and power handling.
- ▶ Ferro-fluid cooled compression driver with titanium diaphragm improves high frequency performance as well as system reliability.
- ▶ The advanced network topology crossover design shapes the frequency response to deliver coherent summation in the crossover region.
- ▶ High-voltage capacitors and inductors with massive cores and heavy gauge wire enable the crossover network to handle high power without saturating.
- ▶ Progressive Transition™ high-frequency waveguide provides superior coverage control, reduced distortion, and smoother frequency response.
- ▶ The rugged, acoustically superior enclosure is constructed from 19 mm (¾ in) MDF (Medium Density Fiberboard) using advanced adhesives and mechanical fastener technology for extreme durability and improved low-frequency performance.
- ▶ SonicGuard™ protects the high-frequency driver from excess power without interrupting the performance.
- ▶ Non-resonant, all-steel handles are used.
- ▶ Attractive 18-gauge perforated, steel grille protects components from damage.
- ▶ Dual-angle pole-mount socket allows the speakers to tilt 10° for more uniform audience coverage.



With JRX118S and SS3-BK



The JRX115 is a portable, fifteen-inch, two-way speaker system designed specifically for applications in live music, music playback, and reinforcement of speech. With the smooth, natural sounding mid-range of the system, the JRX115 does a great job projecting live vocals, solos and speech. The extended lows and great top-end make it at home for music playback in DJ applications or anywhere live sound reinforcement is needed. Features include the dual-angle, 36 mm pole-mount socket as well as Neutrik® Speakon® and ¼" input connectors.

### Specifications:

System Type:	15" 2-way, sound reinforcement speaker
Frequency Range (-10 dB): <sup>2</sup>	38 Hz - 16 kHz
Frequency Response (±3 dB): <sup>2</sup>	50 Hz - 12.5 kHz
Sensitivity (1w/1m):	98 dB SPL
Nominal Impedance:	8 Ω
Power Capacity: <sup>1</sup>	250 watts
Peak Power Capacity: <sup>1</sup>	1000 watts
Recommended Amplifier Power:	250-500 watts @ 8 Ω
Maximum SPL:	128 dB
Nominal Dispersion:	90° x 50°
Crossover Frequency:	1.6 kHz
Dimensions (H x W x D): <sup>3</sup>	699 mm x 460 mm x 432 mm (27.5 in x 18.1 in x 17 in)
Weight:	27.4 kg (60.5 lb)
Shipping Weight:	30.4 kg (67 lb)
High Frequency Driver:	JBL 2412, 1" exit compression driver mounted on Progressive Transition™ Waveguide
Low Frequency Driver:	JBL M115-8A
Input Connectors:	Parallel Neutrik® Speakon® NL-4 (x1); ¼" TS phone jack (x1)
Enclosure Construction:	19 mm (¾ in) MDF (Medium Density Fiberboard); with glued and mechanically fastened joint detail; covered in black carpet.
Grille:	18-gauge, powder-coated steel
Mounting & Suspension:	36 mm, dual-angle pole-mount socket

<sup>1</sup> "Power Capacity" and "Peak Power Capacity" ratings are based on the average and peak power capacity of product samples subjected to a 100 hour power test using random noise with a 6 dB crest factor, in accordance with IEC standards.

<sup>2</sup> "Frequency Range" and "Frequency Response" are based on half-space conditions.

<sup>3</sup> Height dimension includes feet.

JBL continually engages in research related to product improvement. Some materials, production methods and design refinements are introduced into existing products without notice as a routine expression of that philosophy. For this reason, any current JBL product may differ in some respect from its published description, but will always equal or exceed the original design specifications unless otherwise stated.

# ► JRX115 15 Inch Two-Way Speaker

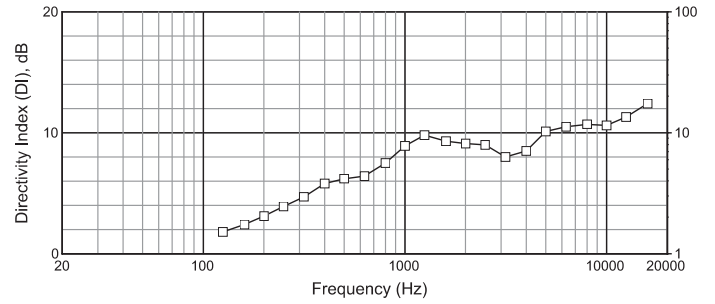
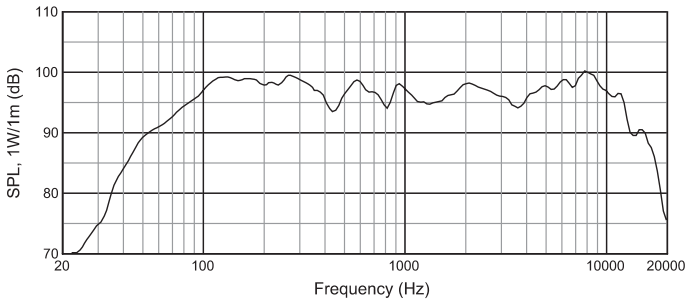
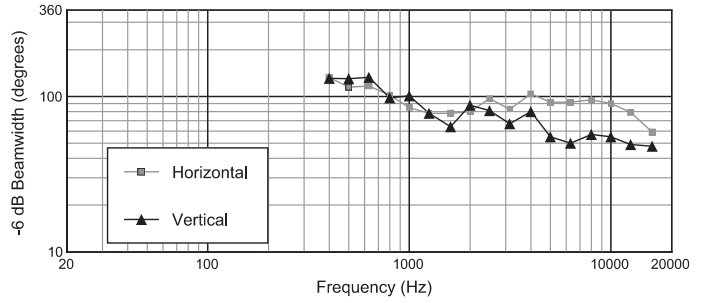
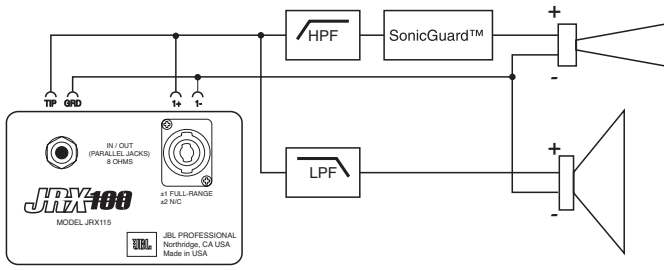

## Dimensions

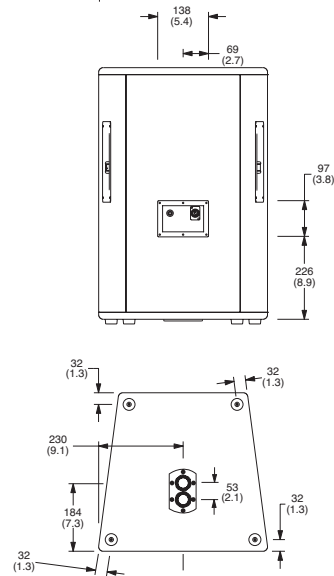
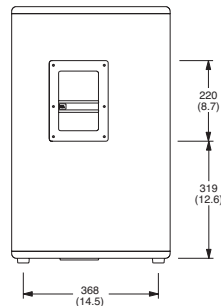
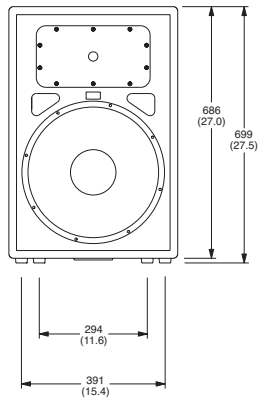
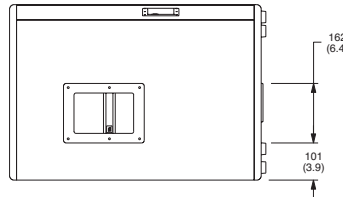
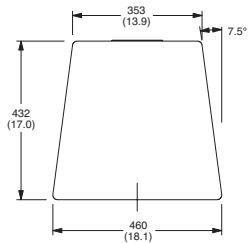

Dimensions in mm (in)



JBL Professional  
8500 Balboa Boulevard, P.O. Box 2200  
Northridge, California 91329 U.S.A.

© A Harman International Company  
© Copyright 2004 JBL Professional

SS JRX115  
352927-001  
CRP 15M  
10/07